

NO	Alteration	NAME
0	MAY. 20. '99 NEW	S. O
1		
2		

F  
i  
g  
u  
r  
e

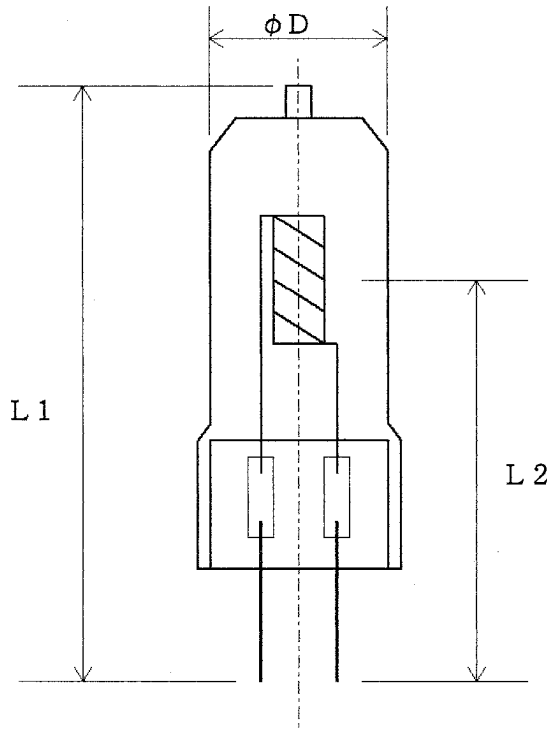

Note  
Base:G6.35  
Burning position:Any

Item		Type	100W	200W	400W	
S I Z E	L1	MAX (mm)	50.0	50.0	60.0	
	L2	$\pm 1.0$ (mm)	30.0	30.0	35.0	
	$\phi D$	MAX (mm)	13.5	13.5	19.0	
L i f e  C h a r a c	Average Life	(Hr)	50	50	50	
	Approx. Lumens	(lm)	2,300	5,000	14,500	
	Color TEMP	(K)	3,100	3,200	3,450	
	Wattage	(W)	100	200	400	
	Voltage	(V)	6	12	24	
	FILAMENT		C-8	C-8	C-Bar-6	

Products	Lamp	Type	APPROVE	CHECK	DESIGN
HALOGEN	JC SHORT LIFE G6.35 BASE		<i>[Signature]</i>		S.O

F  
i  
g  
u  
r  
e

NO	Alteration	NAME
0	JAN. 8. 98' NEW	S. O
1		
2		
3		
4		
5		

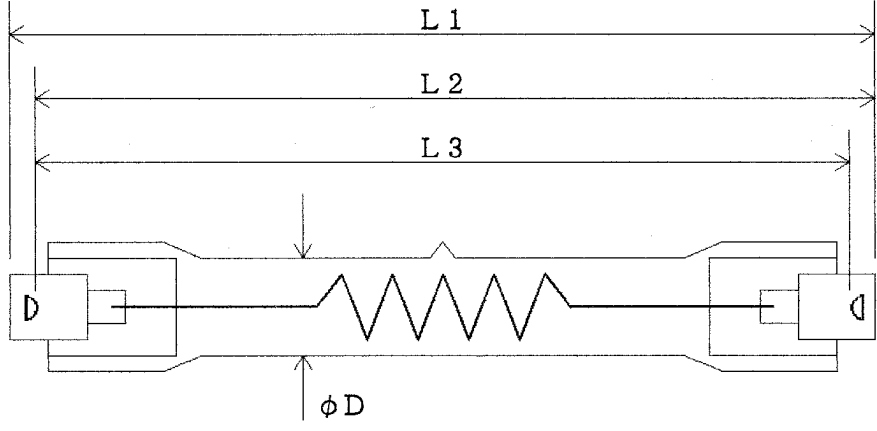

Item		Type	100W	150W	150W	200W
M e a s u r e	L 1	MAX (mm)	65.0	65.0	65.0	65.0
	L 2	MAX (mm)	63.6	63.6	63.6	63.6
	L 3	±1.6 (mm)	60.4	60.4	60.4	60.4
	φD	MAX (mm)	13.5	13.5	13.5	13.5
L i f e  C h a r a c	Average Life	(Hr)	1,000	1,000	1,000	1,000
	Approx. Lumens	(lm)	1,800	2,700	2,700	3,600
	Approx. Color Temp	(K)	2,900	2,900	2,900	2,900
	Wattage	(W)	100	150	150	200
	Voltage	(V)	12	12	24	24
	FILAMENT		C-8	C-8	CC-8	CC-8
	Burning position		HORIZ	HORIZ	HORIZ	HORIZ

Products	Lamp Type	APPROVE	CHECK	DESIGN
HALOGEN	J12V, 24V 65mm R7s BASE	<i>S.M.</i>		S.O

F  
i  
g  
u  
r  
e

NO	Alteration	NAME
0	JAN. 8. 98' NEW	S. 0
1		
2		
3		
4		
5		

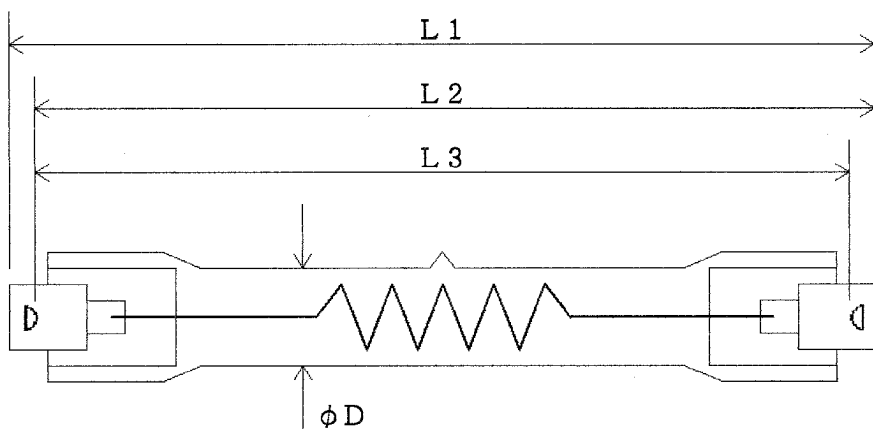

Item		Type	100W	150W	150W	200W
M e a s u r e	L1	MAX (mm)	80.3	80.3	80.3	80.3
	L2	MAX (mm)	78.3	78.3	78.3	78.3
	L3	$\pm 1.6$ (mm)	74.9	74.9	74.9	74.9
	$\phi D$	MAX (mm)	11.0	11.0	11.0	11.0
L i f e	Average Life	(Hr)	1,000	1,000	1,000	1,000
	Approx. Lumens	(lm)	1,800	2,700	2,700	3,600
	Approx. Color Temp	(K)	2,900	2,900	2,900	2,900
C h a r a c	Wattage	(W)	100	150	150	200
	Voltage	(V)	12	12	24	24
	FILAMENT		C-8	C-8	CC-8	CC-8
	Burning position		HORIZ	HORIZ	HORIZ	HORIZ

Products	Lamp	Type	APPROVE	CHECK	DESIGN
HALOGEN	J12V, 24V	78mm R7s BASE			S.0

NO	Alteration	NAME
0	MAR. 25. 99' NEW	S. O
1		
2		
3		
4		
5		

F  
i  
g  
u  
r  
e

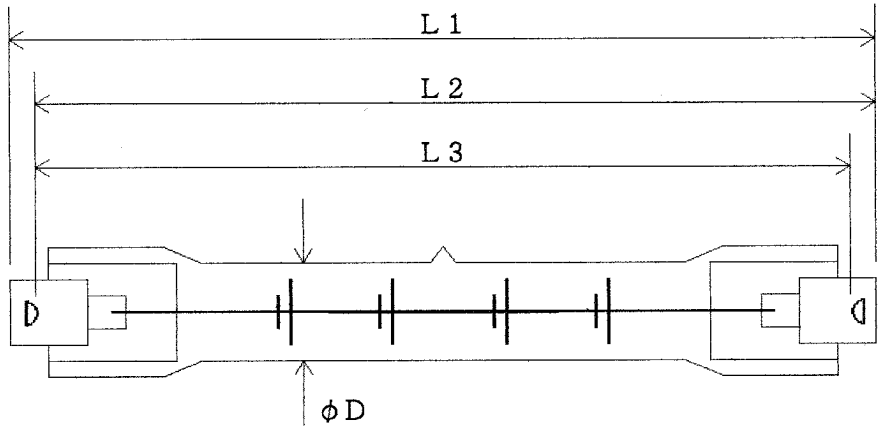

Item		Type	100W	150W		
M e a s u r e	L1	MAX (mm)	119.6	119.6		
	L2	MAX (mm)	117.6	117.6		
	L3	$\pm 1.6$ (mm)	114.2	114.2		
	$\phi D$	MAX (mm)	9.0	9.0		
L i f e  C h a r a c	Average Life	(Hr)	1,500	1,500		
	Approx. Lumens	(lm)	1,500	2,400		
	Approx. Color Temp	(K)	2,800	2,850		
	Wattage	(W)	100	150		
	Voltage	(V)	12	12		
	FILAMENT		C-8	C-8		
	Burning position		HORIZ	HORIZ		

Products	Lamp	Type	APPROVE	CHECK	DESIGN
HALOGEN	J12V 118mm	R7s BASE	<i>[Signature]</i>		S.O

F  
i  
g  
u  
r  
e

NO	Alteration	NAME
0	SEP. 15. '98 NEW	S. O
1	AUG. 02, '99 ADD 150W	S. O
2		
3		
4		
5		

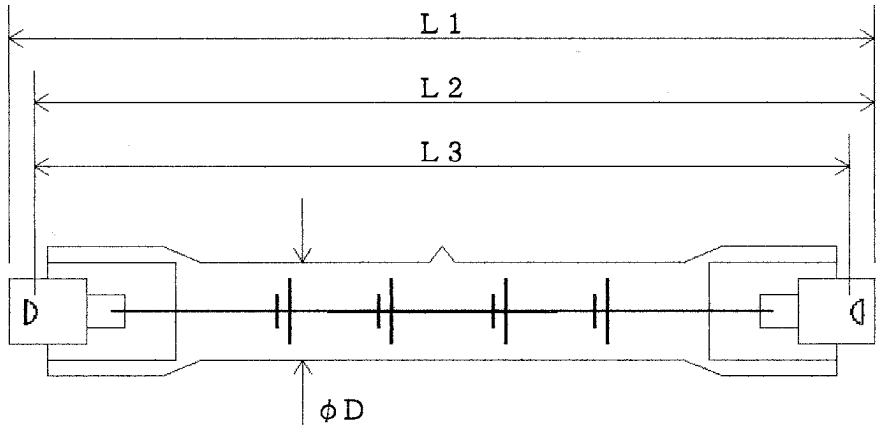

Item		Type	100W	150W	200W	300W
M e a s u r e	L 1	MAX (mm)	119.6	119.6	119.6	119.6
	L 2	MAX (mm)	117.6	117.6	117.6	117.6
	L 3	±1.6 (mm)	114.2	114.2	114.2	114.2
	φD	MAX (mm)	9.0	9.0	9.0	9.0
L i f e  C h a r a c	Average Life	(Hr)	1,500	1,500	1,500	1,500
	Approx. Lumens	(lm)	1,500	2,400	3,200	5,400
	Approx. Color Temp	(K)	2,800	2,850	2,850	2,900
	Wattage	(W)	100	150	200	300
	Voltage	(V)	24	24	24	24
	FILAMENT		C-8	C-8	C-8	C-8
	Burning position		HORIZ	HORIZ	HORIZ	HORIZ

Products	Lamp	Type	APPROVE	CHECK	DESIGN
HALOGEN	J24V 118mm	R7s BASEA	<i>[Signature]</i>		S.O

F  
i  
g  
u  
r  
e

NO	Alteration	NAME
0	MAR. 3. 99' NEW	S. 0
1		
2		
3		
4		
5		

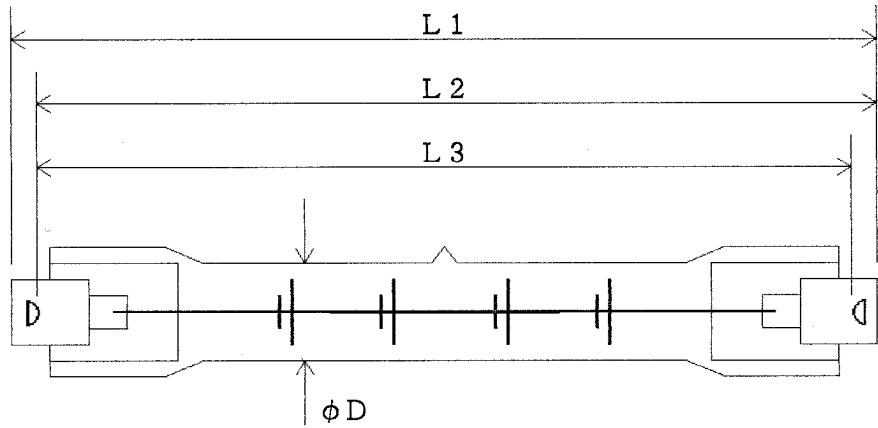

Item		Type	200W	300W	
M e a s u r e	L 1	MAX (mm)	119.6	119.6	
	L 2	MAX (mm)	117.6	117.6	
	L 3	±1.6 (mm)	114.2	114.2	
	φ D	MAX (mm)	9.0	9.0	
L i f e  C h a r a c	Average Life	(Hr)	1,500	1,500	
	Approx. Lumens	(lm)	3,200	5,400	
	Approx. Color Temp	(K)	2,850	2,900	
	Wattage	(W)	200	300	
	Voltage	(V)	28	28	
	FILAMENT		C-8	C-8	
	Burning position		HORIZ	HORIZ	

Products	Lamp	Type	APPROVE	CHECK	DESIGN
HALOGEN	J28V 118mm	R7s BASE	<i>[Signature]</i>		S. 0

F  
i  
g  
u  
r  
e

NO	Alteration	NAME
0	OCT. 18. '00 NEW	S. O
1		
2		
3		
4		
5		

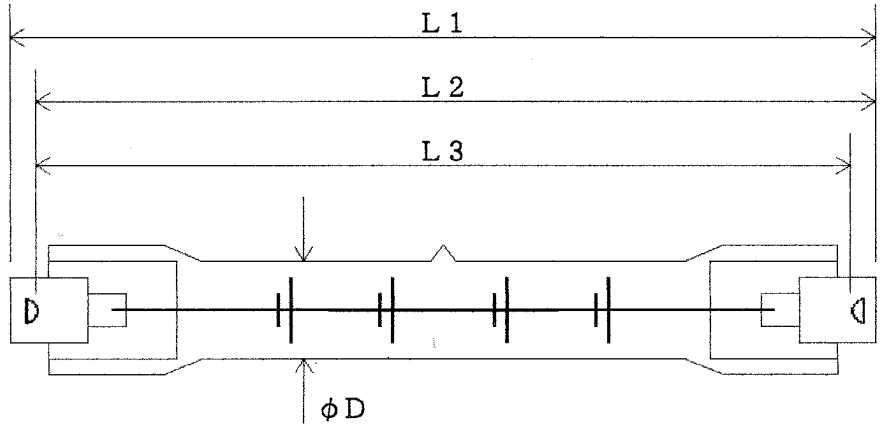

Item	Type		300W	
M e a s u r e	L 1	MAX (mm)	119.6	
	L 2	MAX (mm)	117.6	
	L 3	$\pm 1.6$ (mm)	114.2	
	$\phi D$	MAX (mm)	9.0	
L i f e  C h a r a c	Average Life	(Hr)	1,500	
	Approx. Lumens	(lm)	5,400	
	Approx. Color Temp	(K)	2,900	
	Wattage	(W)	300	
	Voltage	(V)	32	
	FILAMENT		C-8	
	Burning position		HORIZ	

Products	Lamp	Type	APPROVE	CHECK	DESIGN
HALOGEN	J32V	118mm R7s BASE	<i>[Signature]</i>		S.O